

RAY

17-Dec.-2016

1.0 LED

LED 8W | 220-240VAC | 50-60Hz | COB 2-step | incl. PS | phase-cut dim

CE IP20 0.3m 36°

white texture	146764W
aluminium brushed	146764L
gold	146764G
bronze	146764Q
copper	146764P
black texture	146764B

LIGHT COLOUR

2700K >80CRI 600lm	2
3000K >80CRI 600lm	4
1800-2850K >90CRI 410lm	9

1.0 PAR16

PAR16 max. 35W | GU10 | 100-240VAC | 50-60Hz

CE IP20 0.9m

white texture	146720W0
aluminium brushed	146720L0
gold	146720G0
bronze	146720Q0
copper	146720P0
black texture	146720B0

OPTIONAL

for PAR16 lamps see our catalogue

OPTIONAL

single inner cover max. 10W

white texture	911041W1
gold	911041G1
black texture	911041B1

base plate dimensions

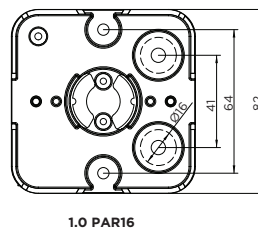
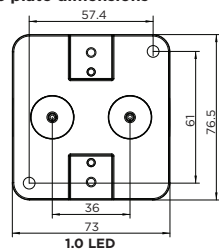

1.0 LED

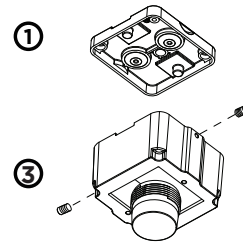

1.0 PAR16

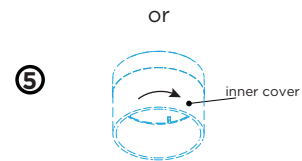
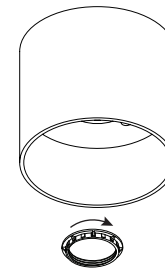
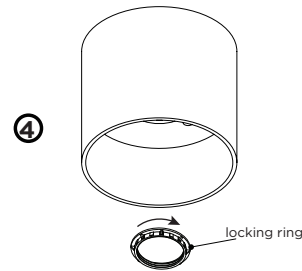
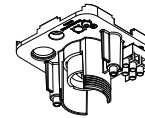

DIMENSIONS

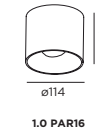

1 MOUNTING INSTRUCTION

Remove the screws of the top part, put the cables through the opening and mount the base on the ceiling.

2 POWER CONNECTION

Connect wiring to the power supply (for LED) or to terminal block (for PAR16) interior connection: STANDARD version

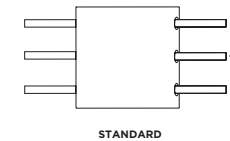

3 FOR LED

Attach the LED housing on the base by two allen screws.

4 FOR LED

Attach the RAY cover to the LED housing by screwing the locking ring

FOR PAR16

Attach the RAY cover to the base by screwing the locking ring

5 OPTIONAL inner cover

put the inner cover in the outer cover by screwing.

with inner cover: **max. 10W**

when using the inner cover you don't need the locking ring.



WEVER & DUCRÉ
LIGHTING

www.weverducre.com

Wever & Ducre bvba Kwadestraat 153 bus 2.1 8800 Roeselare

INSTALLATION
INSTRUCTIONS

PAGE 1/2

RAY

17-Dec.-2016

1.0 LED

LED 8W | 220-240VAC | 50-60Hz | COB 2-step | incl. PS | phase-cut dim

CE IP65 Δ 0.3m Δ 36°

white texture	735364W_
dark grey texture	735364D_
black texture	735364B_

LIGHT COLOUR

3000K >80CRI 600lm	4
1800-2850K >90CRI 410lm	9

OPTIONAL

single inner cover max. 10W

white texture	911041W1
dark grey texture	911041D1
black texture	911041B1

base plate dimensions

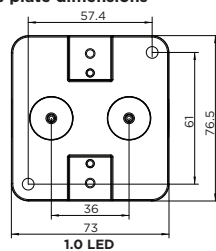

1.0 LED

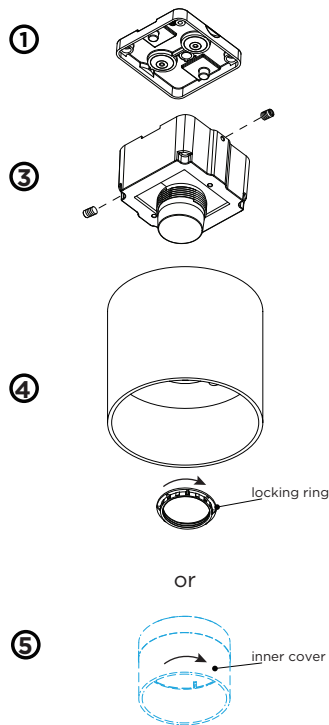

DIMENSIONS

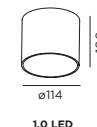

1 MOUNTING INSTRUCTION

Remove the screws of the top part, put the cables through the opening and mount the base on the ceiling.

2 POWER CONNECTION

Connect wiring to the power supply
exterior connection: WATERPROOF version (only for LED)

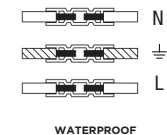

3 Attach the LED housing on the base by two allen screws.

4 Attach the RAY cover to the LED housing by screwing the locking ring

5 **OPTIONAL inner cover**
put the inner cover in the outer cover by screwing.
with inner cover: **max. 10W**
when using the inner cover you don't need the locking ring.



WEVER & DUCRÉ
LIGHTING

www.weverducre.com

Wever & Ducre bvba Kwadestraat 153 bus 2.1 8800 Roeselare

**INSTALLATION
INSTRUCTIONS**

PAGE 2/2