

**PIPISTRELLO**  
code: **620/AL**







DESIGN **GAE AULENTI** 1965

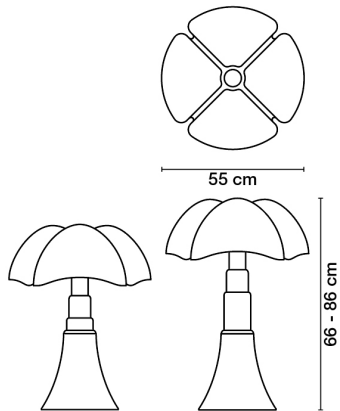

TABLE OR STANDING LAMP WITH DIFFUSED LIGHT, ADJUSTABLE HEIGHT WITH TELESCOPIC MOVEMENT. DIFFUSER IN WHITE OPAL METHACRYLATE. STAINLESS STEEL TELESCOPE. PAINTED METAL BASE AND KNOB IN DARK BROWN /MA, WHITE /BI, PURPLE RED /RO, GLOSSY BLACK /NE AND SATIN ALUMINIUM /AL. DESIGNED IN 1965 BY GAE AULENTI FOR MARTINELLI LUCE, THE LAMP IS MADE WITH INNOVATIVE TECHNIQUES FOR THE DIFFUSER IN METHACRYLATE FOR THE TIME IN WHICH IT WAS DESIGNED. THE SHAPE OF CONIC BASE GROWS IN THE HEIGHT THROUGH THE RIBS OF THE DIFFUSER AS THE WINGS OF A BAT. RESTING ON A TABLE OR STANDING ON FLOOR THIS LAMP FEATURES WITH ITS EXPRESSIVE POWER ANY TYPE OF ENVIRONMENT.

## TECHNICAL DRAWINGS



|   |   |   |   |
|---|---|---|---|
| <b>UTILIZATION:</b> INTERNAL  |   | <b>TPOLOGY:</b> TABLE LAMPS  |   |
| <b>COLOURS</b>  | STRUCTURE:<br>DIFFUSER:   | <b>SATIN ALUMINIUM<br/>WHITE</b>  |   |
| <b>MATERIALS</b>  | STRUCTURE:<br>DIFFUSER:   | <b>STAINLESS STEEL<br/>OPAL WHITE METHACRYLATE</b>  |   |
| <b>MEASURES</b>   | WIDTH: -<br>HEIGHT: <b>66 - 86 cm</b><br>LENGTH: -<br>DEPTH: -  | DIAMETER: <b>55 cm</b><br>HOLE DIAMETER: -<br>HOLE DEPTH: -   | WEIGHT NET: <b>10</b><br>GROSS: <b>14</b> |
|   | PACKAGING VOL.M <sup>3</sup> : <b>54X54X26 - 41X41X78</b>   |   | NUMBER OF ITEMS: <b>2</b>                 |
| <b>BULBS</b>  | LED 4X5W E14<br>FLUX: 1880LM<br>KELVIN: 2700°<br>CLASS: A+<br>CRI: >80<br>COLOR TOLERANCE: -<br>DURATION: 25000H  |   |   |
|  |   |   |   |
| <b>DEVICE SPECIFICATIONS</b>  |   |   |   |
| TYPE OF EMISSION: <b>DIFFUSED</b>   |   | POWER SUPPLY CABLE LENGTH: <b>45+200cm</b>  |   |
| POWER: -  |   | LENGTH OF HANGING CABLE: -  |   |
| FLOW LAMP: -  |   | SUPPLY: -   |   |
| BEAM ANGLE: -   |   | POWER SUPPLY ASSEMBLY: -  |   |
| DEVICE EFFICIENCY: <b>-lm/W</b>   |   | TYPE OF DIMMING: -  |   |
| IMPACT RESISTANCE: -  |   | VOLTAGE: <b>230 V</b>   |   |
| GLOW WIRE TEST: -   |   | POWER SUPPLY: -   |   |
| <b>CERTIFICATIONS</b>   |      |   |   |
| <b>MARKETS</b>  | THIS ITEM IS AVAILABLE IN THE FOLLOWING COUNTRIES:<br><b>EUROPE</b>   |   |   |

**PIPISTRELLO**  
code: **620/AL**

DESIGN **GAE AULENTI** 1965

PHOTO GALLERY



## PIPISTRELLO

code: **620/BI**







DESIGN **GAE AULENTI** 1965

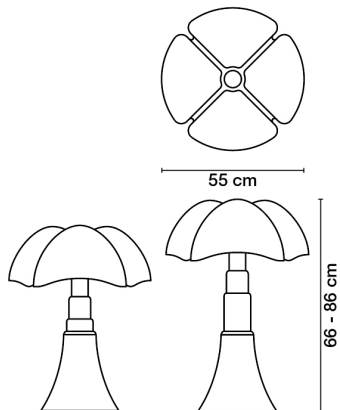

TABLE OR STANDING LAMP WITH DIFFUSED LIGHT, ADJUSTABLE HEIGHT WITH TELESCOPIC MOVEMENT. DIFFUSER IN WHITE OPAL METHACRYLATE. STAINLESS STEEL TELESCOPE. PAINTED METAL BASE AND KNOB IN DARK BROWN /MA, WHITE /BI, PURPLE RED /RO, GLOSSY BLACK /NE AND SATIN ALUMINIUM /AL. DESIGNED IN 1965 BY GAE AULENTI FOR MARTINELLI LUCE, THE LAMP IS MADE WITH INNOVATIVE TECHNIQUES FOR THE DIFFUSER IN METHACRYLATE FOR THE TIME IN WHICH IT WAS DESIGNED. THE SHAPE OF CONIC BASE GROWS IN THE HEIGHT THROUGH THE RIBS OF THE DIFFUSER AS THE WINGS OF A BAT. RESTING ON A TABLE OR STANDING ON FLOOR THIS LAMP FEATURES WITH ITS EXPRESSIVE POWER ANY TYPE OF ENVIRONMENT.

### TECHNICAL DRAWINGS



|   |   |   |   |
|---|---|---|---|
| <b>UTILIZATION:</b> INTERNAL  |   | <b>TPOLOGY:</b> TABLE LAMPS  |   |
| <b>COLOURS</b>  | STRUCTURE:<br>DIFFUSER:   | <b>WHITE<br/>WHITE</b>  |   |
| <b>MATERIALS</b>  | STRUCTURE:<br>DIFFUSER:   | <b>STAINLESS STEEL<br/>OPAL WHITE METHACRYLATE</b>  |   |
| <b>MEASURES</b>   | WIDTH: -<br>HEIGHT: <b>66 - 86 cm</b><br>LENGTH: -<br>DEPTH: -  | DIAMETER: <b>55 cm</b><br>HOLE DIAMETER: -<br>HOLE DEPTH: -   | WEIGHT NET: <b>10</b><br>GROSS: <b>14</b> |
|   | PACKAGING VOL.M <sup>3</sup> : <b>54X54X26 - 41X41X78</b>   |   | NUMBER OF ITEMS: <b>2</b>                 |
| <b>BULBS</b>  | LED 4X5W E14<br>FLUX: 1880LM<br>KELVIN: 2700°<br>CLASS: A+<br>CRI: >80<br>COLOR TOLERANCE: -<br>DURATION: 25000H  |   |   |
|  |   |   |   |
| <b>DEVICE SPECIFICATIONS</b>  |   |   |   |
| TYPE OF EMISSION: <b>DIFFUSED</b>   |   | POWER SUPPLY CABLE LENGTH: <b>45+200cm</b>  |   |
| POWER: -  |   | LENGTH OF HANGING CABLE: -  |   |
| FLOW LAMP: -  |   | SUPPLY: -   |   |
| BEAM ANGLE: -   |   | POWER SUPPLY ASSEMBLY: -  |   |
| DEVICE EFFICIENCY: <b>-lm/W</b>   |   | TYPE OF DIMMING: -  |   |
| IMPACT RESISTANCE: -  |   | VOLTAGE: <b>230 V</b>   |   |
| GLOW WIRE TEST: -   |   | POWER SUPPLY: -   |   |
| <b>CERTIFICATIONS</b>   |      |   |   |
| <b>MARKETS</b>  | THIS ITEM IS AVAILABLE IN THE FOLLOWING COUNTRIES:<br><b>EUROPE</b>   |   |   |

**PIPISTRELLO**  
code: *620/BI*

DESIGN **GAE AULENTI** 1965

PHOTO GALLERY

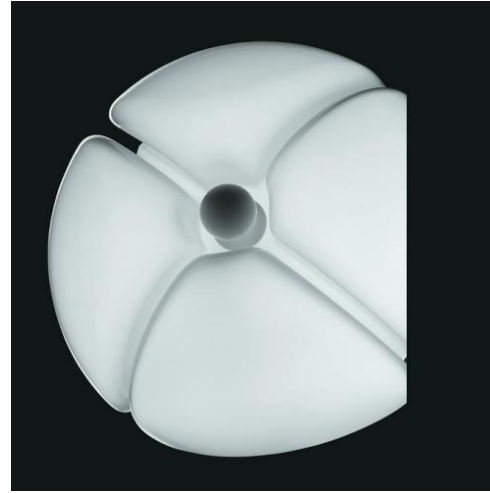

**PIPISTRELLO**  
code: **620/MA**







DESIGN **GAE AULENTI** 1965

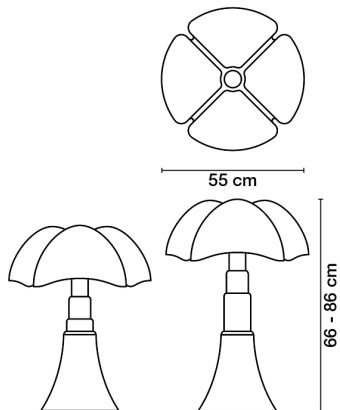

TABLE OR STANDING LAMP WITH DIFFUSED LIGHT, ADJUSTABLE HEIGHT WITH TELESCOPIC MOVEMENT. DIFFUSER IN WHITE OPAL METHACRYLATE. STAINLESS STEEL TELESCOPE. PAINTED METAL BASE AND KNOB IN DARK BROWN /MA, WHITE /BI, PURPLE RED /RO, GLOSSY BLACK /NE AND SATIN ALUMINIUM /AL. DESIGNED IN 1965 BY GAE AULENTI FOR MARTINELLI LUCE, THE LAMP IS MADE WITH INNOVATIVE TECHNIQUES FOR THE DIFFUSER IN METHACRYLATE FOR THE TIME IN WHICH IT WAS DESIGNED. THE SHAPE OF CONIC BASE GROWS IN THE HEIGHT THROUGH THE RIBS OF THE DIFFUSER AS THE WINGS OF A BAT. RESTING ON A TABLE OR STANDING ON FLOOR THIS LAMP FEATURES WITH ITS EXPRESSIVE POWER ANY TYPE OF ENVIRONMENT.

## TECHNICAL DRAWINGS



|                              |   |  |   |   |
|------------------------------|---|--|---|---|
| <b>UTILIZATION:</b>          | <b>INTERNAL</b>   | <b>TIPOLOGY:</b>   | <b>TABLE LAMPS</b>                        |  |
| <b>COLOURS</b>               | STRUCTURE:<br>DIFFUSER:   | <b>DARK BROWN</b><br><b>WHITE</b>  |   |   |
| <b>MATERIALS</b>             | STRUCTURE:<br>DIFFUSER:   | <b>STAINLESS STEEL</b><br><b>OPAL WHITE METHACRYLATE</b>   |   |   |
| <b>MEASURES</b>              | WIDTH: -<br>HEIGHT: <b>66 - 86 cm</b><br>LENGTH: -<br>DEPTH: -  | DIAMETER: <b>55 cm</b><br>HOLE DIAMETER: -<br>HOLE DEPTH: -  | WEIGHT NET: <b>10</b><br>GROSS: <b>14</b> |   |
|                              | PACKAGING VOL.M <sup>3</sup> : <b>54X54X26 - 41X41X78</b>   |  | NUMBER OF ITEMS: <b>2</b>                 |   |
| <b>BULBS</b>                 | LED 4X5W E14<br>FLUX: 1880LM<br>KELVIN: 2700°<br>CLASS: A+<br>CRI: >80<br>COLOR TOLERANCE: -<br>DURATION: 25000H  |  |   |  |
| <b>DEVICE SPECIFICATIONS</b> | TYPE OF EMISSION: <b>DIFFUSED</b><br>POWER: -<br>FLOW LAMP: -<br>BEAM ANGLE: -<br>DEVICE EFFICIENCY: <b>-lm/W</b><br>IMPACT RESISTANCE: -<br>GLOW WIRE TEST: -  | POWER SUPPLY CABLE LENGTH: <b>45+200cm</b><br>LENGTH OF HANGING CABLE: -<br>SUPPLY: -<br>POWER SUPPLY ASSEMBLY: -<br>TYPE OF DIMMING: -<br>VOLTAGE: <b>230 V</b> |   |   |
| <b>CERTIFICATIONS</b>        |      |  |   |   |
| <b>MARKETS</b>               | THIS ITEM IS AVAILABLE IN THE FOLLOWING COUNTRIES:<br><b>EUROPE</b>   |  |   |   |

**PIPISTRELLO**  
code: *620/MA*

DESIGN **GAE AULENTI** 1965

PHOTO GALLERY

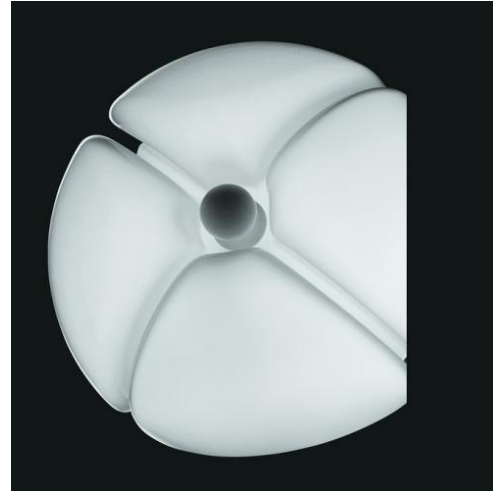

**PIPISTRELLO**  
code: **620/NE**







DESIGN **GAE AULENTI** 1965

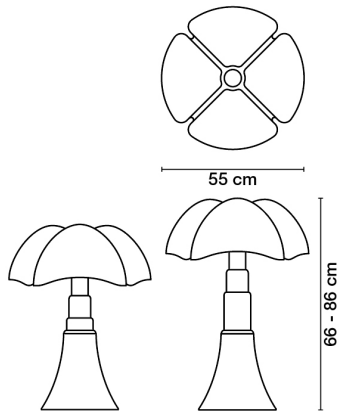

TABLE OR STANDING LAMP WITH DIFFUSED LIGHT, ADJUSTABLE HEIGHT WITH TELESCOPIC MOVEMENT. DIFFUSER IN WHITE OPAL METHACRYLATE. STAINLESS STEEL TELESCOPE. PAINTED METAL BASE AND KNOB IN DARK BROWN /MA, WHITE /BI, PURPLE RED /RO, GLOSSY BLACK /NE AND SATIN ALUMINIUM /AL. DESIGNED IN 1965 BY GAE AULENTI FOR MARTINELLI LUCE, THE LAMP IS MADE WITH INNOVATIVE TECHNIQUES FOR THE DIFFUSER IN METHACRYLATE FOR THE TIME IN WHICH IT WAS DESIGNED. THE SHAPE OF CONIC BASE GROWS IN THE HEIGHT THROUGH THE RIBS OF THE DIFFUSER AS THE WINGS OF A BAT. RESTING ON A TABLE OR STANDING ON FLOOR THIS LAMP FEATURES WITH ITS EXPRESSIVE POWER ANY TYPE OF ENVIRONMENT.

## TECHNICAL DRAWINGS



|   |   |   |   |
|---|---|---|---|
| <b>UTILIZATION:</b> INTERNAL  |   | <b>TPOLOGY:</b> TABLE LAMPS  |   |
| <b>COLOURS</b>  | STRUCTURE:<br>DIFFUSER:   | <b>BLACK</b><br><b>WHITE</b>  |   |
| <b>MATERIALS</b>  | STRUCTURE:<br>DIFFUSER:   | <b>STAINLESS STEEL</b><br><b>OPAL WHITE METHACRYLATE</b>  |   |
| <b>MEASURES</b>   | WIDTH: -<br>HEIGHT: <b>66 - 86 cm</b><br>LENGTH: -<br>DEPTH: -  | DIAMETER: <b>55 cm</b><br>HOLE DIAMETER: -<br>HOLE DEPTH: -   | WEIGHT NET: <b>10</b><br>GROSS: <b>14</b> |
|   | PACKAGING VOL.M <sup>3</sup> : <b>54X54X26 - 41X41X78</b>   |   | NUMBER OF ITEMS: <b>2</b>                 |
| <b>BULBS</b>  | LED 4X5W E14<br>FLUX: 1880LM<br>KELVIN: 2700°<br>CLASS: A+<br>CRI: >80<br>COLOR TOLERANCE: -<br>DURATION: 25000H  |   |   |
|  |   |   |   |
| <b>DEVICE SPECIFICATIONS</b>  |   |   |   |
| TYPE OF EMISSION: <b>DIFFUSED</b>   |   | POWER SUPPLY CABLE LENGTH: <b>45+200cm</b>  |   |
| POWER: -  |   | LENGTH OF HANGING CABLE: -  |   |
| FLOW LAMP: -  |   | SUPPLY: -   |   |
| BEAM ANGLE: -   |   | POWER SUPPLY ASSEMBLY: -  |   |
| DEVICE EFFICIENCY: <b>-lm/W</b>   |   | TYPE OF DIMMING: -  |   |
| IMPACT RESISTANCE: -  |   | VOLTAGE: <b>230 V</b>   |   |
| GLOW WIRE TEST: -   |   |   |   |
| POWER SUPPLY: -   |   |   |   |
| <b>CERTIFICATIONS</b>   |      |   |   |
| <b>MARKETS</b>  | THIS ITEM IS AVAILABLE IN THE FOLLOWING COUNTRIES:<br><b>EUROPE</b>   |   |   |

**PIPISTRELLO**  
code: **620/NE**

DESIGN **GAE AULENTI** 1965

PHOTO GALLERY

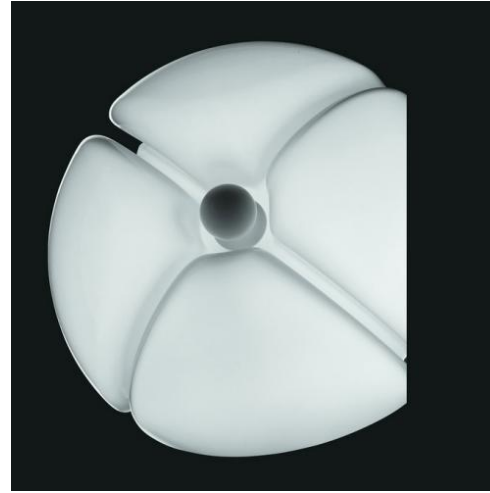



**PIPISTRELLO**  
code: **620/RO**



DESIGN **GAE AULENTI** 1965

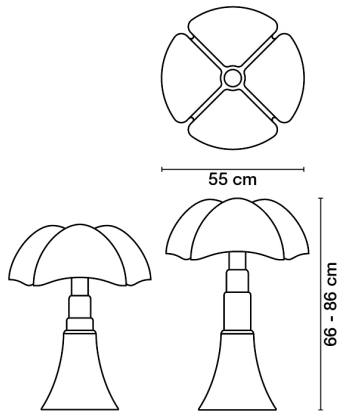

TABLE OR STANDING LAMP WITH DIFFUSED LIGHT, ADJUSTABLE HEIGHT WITH TELESCOPIC MOVEMENT. DIFFUSER IN WHITE OPAL METHACRYLATE. STAINLESS STEEL TELESCOPE. PAINTED METAL BASE AND KNOB IN DARK BROWN /MA, WHITE /BI, PURPLE RED /RO, GLOSSY BLACK /NE AND SATIN ALUMINIUM /AL. DESIGNED IN 1965 BY GAE AULENTI FOR MARTINELLI LUCE, THE LAMP IS MADE WITH INNOVATIVE TECHNIQUES FOR THE DIFFUSER IN METHACRYLATE FOR THE TIME IN WHICH IT WAS DESIGNED. THE SHAPE OF CONIC BASE GROWS IN THE HEIGHT THROUGH THE RIBS OF THE DIFFUSER AS THE WINGS OF A BAT. RESTING ON A TABLE OR STANDING ON FLOOR THIS LAMP FEATURES WITH ITS EXPRESSIVE POWER ANY TYPE OF ENVIRONMENT.

TECHNICAL DRAWINGS



|   |  |   |   |
|---|--|---|---|
| <b>UTILIZATION:</b> INTERNAL  |  | <b>TPOLOGY:</b> TABLE LAMPS  |   |
| <b>COLOURS</b>  | STRUCTURE:<br>DIFFUSER:  | <b>PURPLE RED<br/>WHITE</b>   |   |
| <b>MATERIALS</b>  | STRUCTURE:<br>DIFFUSER:  | <b>STAINLESS STEEL<br/>OPAL WHITE METHACRYLATE</b>  |   |
| <b>MEASURES</b>   | WIDTH: -<br>HEIGHT: <b>66 - 86 cm</b><br>LENGTH: -<br>DEPTH: -   | DIAMETER: <b>55 cm</b><br>HOLE DIAMETER: -<br>HOLE DEPTH: -   | WEIGHT NET: <b>10</b><br>GROSS: <b>14</b> |
|   | PACKAGING VOL.M <sup>3</sup> : <b>54X54X26 - 41X41X78</b>  |   | NUMBER OF ITEMS: <b>2</b>                 |
| <b>BULBS</b>  | LED 4X5W E14<br>FLUX: 1880LM<br>KELVIN: 2700°<br>CLASS: A+<br>CRI: >80<br>COLOR TOLERANCE: -<br>DURATION: 25000H |   |   |
|  |  |   |   |
| <b>DEVICE SPECIFICATIONS</b>  |  |   |   |
| TYPE OF EMISSION: <b>DIFFUSED</b>   |  | POWER SUPPLY CABLE LENGTH: <b>45+200cm</b>  |   |
| POWER: -  |  | LENGTH OF HANGING CABLE: -  |   |
| FLOW LAMP: -  |  | SUPPLY: -   |   |
| BEAM ANGLE: -   |  | POWER SUPPLY ASSEMBLY: -  |   |
| DEVICE EFFICIENCY: <b>-lm/W</b>   |  | TYPE OF DIMMING: -  |   |
| IMPACT RESISTANCE: -  |  | VOLTAGE: <b>230 V</b>   |   |
| GLOW WIRE TEST: -   |  | POWER SUPPLY: -   |   |
| <b>CERTIFICATIONS</b>   |                             |   |   |
| <b>MARKETS</b>  | THIS ITEM IS AVAILABLE IN THE FOLLOWING COUNTRIES:<br><b>EUROPE</b>  |   |   |

**PIPISTRELLO**  
code: *620/RO*

DESIGN **GAE AULENTI** 1965

PHOTO GALLERY

